



GE25-UK

Spherical plain bearing

Schaeffler ID:
0066500740000

Radial spherical plain bearing, maintenance-free, sliding layer: PTFE composite, inner ring curved surface with hard chromium coating, DIN ISO 12240-1, dimension series E, open design

Technical information

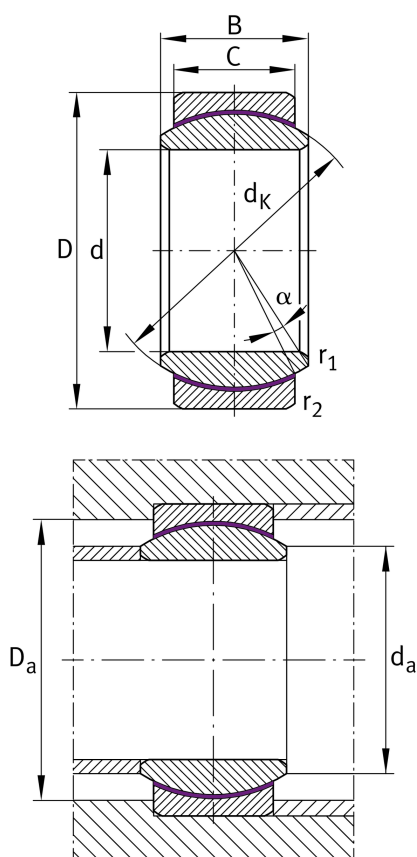

Main Dimensions & Performance Data

D	42 mm	Outside diameter bearing
d	25 mm	Bore diameter bearing
B	20 mm	Width Inner ring
C	16 mm	Width Outer ring
C_r	51,100 N	Basic dynamic load rating, radial
C_{0r}	128,000 N	Basic static load rating, radial
	0.115 kg	Weight

Dimensions

d_k	35.5 mm	Ball diameter
α	7 °	Tilt angle
G_r	0 - 0,05 mm	Radial Clearance
d_{OT}	0 mm	Bore diameter bearing, upper tolerance
d_{UT}	-0.01 mm	Bore diameter bearing, lower tolerance
D_{OT}	0 mm	Outside diameter, upper tolerance
D_{UT}	-0.011 mm	Outside diameter, lower tolerance
B_{OT}	0 mm	Width inner ring, upper tolerance
B_{UT}	-0.12 mm	Width inner ring, lower tolerance
C_{OT}	0 mm	Width outer ring, upper tolerance

Mounting dimensions

r_{1smin}	0.6 mm	Edge Spacing
r_{2smin}	0.6 mm	Edge Spacing
d_{amax}	29.3 mm	Connection measure Inner ring
D_{amin}	33 mm	Housing Connection Diameter

Temperature range

T_{min}	-50 °C	Operating temperature min.
T_{max}	200 °C	Operating temperature max.